

EXPERT GROUP ON GUIDANCE REQUIRED UNDER ARTICLE 8 OF THE MINAMATA CONVENTION ON MERCURY

Non-ferrous metal smelting sub-group (Copper, Gold, Lead and Zinc)

BAT/BEP Guidance and Case Studies

Table of Contents

| | | |
|-------|---|----|
| 1 | Introduction | 4 |
| 2 | Process Descriptions | 5 |
| 2.1 | Process steps in lead production | 5 |
| 2.1.1 | Concentrate Pre-treatment..... | 6 |
| 2.1.2 | Smelting | 6 |
| 2.1.3 | Refining..... | 6 |
| 2.1.4 | Sulfuric Acid Plant..... | 6 |
| 2.2 | Process steps in zinc production | 8 |
| 2.2.1 | Blending, roasting and dust recovery..... | 8 |
| 2.2.2 | Gas cleaning..... | 8 |
| 2.2.3 | Sulfuric acid plant | 10 |
| 2.2.4 | Leaching..... | 10 |
| 2.3 | Process Steps in Copper Production | 10 |
| 2.3.1 | Concentrate Drying | 11 |
| 2.3.2 | Roasting | 11 |
| 2.3.3 | Smelting | 11 |
| 2.3.4 | Converting..... | 11 |
| 2.3.5 | Refining & Casting | 11 |
| 2.3.6 | Slag Cleaning | 12 |
| 2.3.7 | Sulfuric Acid Plant..... | 12 |
| 2.4 | Process Steps in Gold production | 14 |
| 2.4.1 | Roasting | 14 |
| 2.4.2 | Leaching..... | 14 |
| 2.4.3 | Stripping and Regeneration..... | 14 |
| 2.4.4 | Refining..... | 15 |
| 2.4.5 | Furnace..... | 15 |

| | | |
|-------|---|----|
| 3 | Emission control techniques..... | 17 |
| 3.1 | Boliden Norzink process..... | 17 |
| 3.1.1 | Description..... | 17 |
| 3.1.2 | Applicability | 19 |
| 3.1.3 | Performance | 20 |
| 3.1.4 | Cross-media impacts..... | 20 |
| 3.1.5 | Costs of installation and operation..... | 20 |
| 3.2 | Removal by reaction with sulfuric acid | 20 |
| 3.2.1 | Description..... | 20 |
| 3.3 | Selenium filter..... | 22 |
| 3.3.1 | Description..... | 22 |
| 3.3.2 | Applicability | 22 |
| 3.3.3 | Performance level | 23 |
| 3.3.4 | Costs of installation and operation..... | 23 |
| 3.3.5 | Cross-media impacts..... | 23 |
| 3.4 | Activated carbon filter | 24 |
| 3.4.1 | Description..... | 24 |
| 3.4.2 | Applicability | 24 |
| 3.4.3 | Performance level | 24 |
| 3.4.4 | Costs of Installation and Operation..... | 24 |
| 3.4.5 | Co-Benefits | 25 |
| 3.4.6 | Cross Media Impacts..... | 25 |
| 3.5 | The DOWA filter process (lead(II) sulfide covered pumice filter)..... | 25 |
| 3.6 | Co-benefits of common air pollution abatement technologies and acid plants in mercury control | 26 |
| 3.6.1 | Pollution Abatement Technologies..... | 26 |
| 3.6.2 | Combined gas cleaning and acid plants | 26 |
| 4 | Emerging and Other Processes..... | 28 |
| 4.1 | Selenium Scrubber | 28 |
| 4.2 | Jerritt process | 29 |
| 4.2.1 | Description..... | 29 |
| 4.2.2 | Applicability | 29 |
| 4.2.3 | Performance | 29 |

| | | |
|-------|--|----|
| 4.2.4 | Cross-media impacts | 29 |
| 4.2.5 | Costs of installation and operation..... | 30 |
| 5 | Best Available Techniques and Best Environmental Practices | 31 |
| 5.1 | BAT Overview | 31 |
| 5.1.1 | Some other considerations in the choice of mercury control in smelting and roasting in the non-ferrous metals sector | 33 |
| 5.2 | Best Environmental Practices (BEP) | 36 |
| 5.2.1 | Environmental management systems..... | 36 |
| 5.2.2 | Blending feedstocks to control mercury emissions..... | 36 |
| 5.2.3 | Atmospheric mercury emissions..... | 37 |
| 5.2.4 | Particulate matter control..... | 37 |
| 5.2.5 | Environmentally sound management and disposal of air pollution control wastes | 37 |
| 6 | Monitoring of mercury in smelting and refining processes used in the production of non-ferrous metals | 38 |
| 6.1 | Direct Measurement Methods..... | 38 |
| 6.2 | Indirect measurement Methods..... | 39 |
| 7 | References | 41 |

1 Introduction

Mercury exists as a trace element in nearly all metallurgical raw materials and hence thermal processing and other smelting operations have the potential to release mercury to the atmosphere. The main aim of the smelting process is to convert metals from their native state in ores to pure metals and hence smelting is a form of extractive metallurgy. Metals commonly exist in nature as oxides, sulfides, or carbonates and the smelting process requires a chemical reaction in the presence of a reducing agent to liberate the metal.

The 2013 UNEP Report on the Global Mercury Assessment (AMAP/UNEP 2013) presents an emissions inventory for 2010, which, while based on, and similar in total to the 2005 inventory which was presented in a 2008 UNEP Report (AMAP/UNEP 2008), contains a number of significant differences in some of the key sectors. Data in both these inventories illustrate that metal production in general, and non-ferrous metal production in particular, is a large anthropogenic source of mercury emissions and estimated to account for around 10% of global emission. It is recognized that this estimate is subject to considerable uncertainty, and that site specific data will be required to manage mercury at the local plant level.

This guidance document addresses the control options for mercury from the non-ferrous metal sector (specifically for copper, zinc, lead and industrial gold as listed in the Convention). It aims to provide Parties to the Minamata Convention with guidance on identifying best available techniques (BAT) and best environmental practices (BEP) to enable them to meet their obligations under the convention.

The guidance refers only to emissions from smelting and roasting processes used in the production of the above-mentioned non-ferrous metals. Processes other than smelting and roasting, such as hydrometallurgical processes, may also lead to emissions of mercury but they are not included in the Convention as listed in Annex D. Therefore, these other processes are not addressed in this guidance.

Secondary metals smelting produces negligible amounts of mercury emissions, because these are metals recycling processes that use scrap metal and drosses as feed. The only case where there may be small amounts of mercury released is during the recycling of zinc batteries that contain trace amounts of mercury. Given the treaty requirements on products (controlled under Article 4, with permitted mercury content of button zinc silver oxide batteries set out in Annex A), the mercury content of batteries is also expected to decrease significantly.

This is supported by available data on mercury emissions from secondary smelters. For example, the USEPA required testing for mercury emissions from several secondary lead smelters in the US in about 2010 and established that in about 70 per cent of cases the emissions were below the detection limit.

In secondary smelting, there are no mercury-specific control technologies. ~~In fact, secondary smelting may be more of a concern for dioxins and furans.~~ Thus, secondary smelting is not addressed in this guidance.

2 Process Descriptions

The configuration of smelting and roasting operations depends on site conditions and specific characteristics of the ores/concentrates being processed, and multiple steps are often involved. In this section, general brief descriptions of the relevant smelting and roasting processes for the lead, zinc, copper and industrial gold sectors are given.

The first stage in the processing of lead, zinc and copper ores is the production of concentrates. The concentrates are then often initially processed using a high temperature thermal process such as roasting, sintering and/or smelting. Due to the high temperature, mercury will be volatilized and thus be present in the exhaust gas.

In the exhaust gas, mercury will be adsorbed on particulate matter or present as soluble mercury compounds (e.g., mercury(II) chloride), and will also be present as elemental mercury. Oxidised species of mercury can normally be removed by using scrubbers, and wet electrostatic precipitators. ~~Particulate-bound oxidized mercury can be removed by baghouses. However elemental mercury passes all such standard gas cleaning equipment. Therefore a second mercury removal stage may be needed to reduce mercury to acceptable concentrations if mercury is present in the ore. Options are presented in Section 3.~~

dry and water
only

The reason elemental mercury cannot be effectively removed from an ambient temperature gas stream by scrubbing with water alone is due to its low solubility in water. One possibility is to adsorb mercury on sorbents like activated carbon. Another possibility is to oxidise mercury in some suitable manner, which can then be collected in solution or in the form of some solid compound.

If sulfidic raw materials are processed, the gas will contain sulfur dioxide, which is normally used to produce sulfuric acid. To produce sulfuric acid that meets commercial standards, low mercury content of the acid is required and will depend on the ultimate use of the acid.

Techniques to reduce mercury emissions from smelting and roasting in the non-ferrous sector may also result in the production of mercury-containing materials. An example is calomel (mercury(I) chloride), produced in the Boliden-Norzink process (see Section 3.1). This guidance does not address the management of these materials but under Article 11 of the Convention they should be stored or disposed of in an environmentally sound manner as waste.

Mercury may also be present in the wastewater produced by these processes and will require similar storage or management. Wastewater from the different sections of the plants is usually treated to remove harmful elements, such as heavy metals, residual oils or trace chemical reagents. Mercury is often precipitated as a very poorly soluble mercury sulfide and removed by decantation and filtration. The final sludge from the wastewater treatment plant is stored appropriately as waste. The sludge containing mercury should be disposed of in an environmentally sound manner.

recycled or

2.1 Process steps in lead production

The primary lead production process consists of three main stages: concentrate pre-treatment; sintering and/or smelting; and refining. A schematic representation of the process is presented in Figure 1. Mercury is liberated mainly during the sintering and smelting processes and must be captured to minimize mercury emissions from the final stack.

2.1.1 Concentrate Pre-treatment

In the concentrate pre-treatment stage, various lead concentrates are blended to form a homogenous feed to the smelting process. Concentrate blending provides a more consistent metal content in the feedstock and reduces surges of impurities that could cause process or environmental upsets, or product quality issues. During blending, other raw materials may be added, such as fluxes or particulate matter recovered downstream from pollution control devices. Depending on process requirements, the blended lead concentrates may be dried to reduce moisture content. Some mercury emissions may be released during drying, either as gaseous mercury or as particulate matter.

2.1.2 Smelting

Two main processes exist for smelting lead concentrates. The traditional process consists of first sintering the blended lead concentrates to remove sulfur and produce lead oxide. The lead oxide sinter product is then fed to a blast furnace where it is reduced to lead bullion using coke.

The second, more recently developed process, is the direct smelting of lead concentrates (also known as flash smelting). In direct smelting, the oxidation and reduction of the lead occurs within a single furnace. Heat released by the oxidation of sulfur in the concentrate drives the subsequent reduction reaction to produce lead bullion using coal. Compared to the sinter-blast furnace smelting process, direct smelting uses less energy and generates lower levels of air emissions due to better sealing and capture of off-gas.

The off-gas from the sintering or direct smelting process contains particulate matter, sulfur dioxide, mercury and other metals. The off-gas must be sent for gas cleaning prior to sulfuric acid production.

2.1.3 Refining

The lead bullion is refined through several stages of pyrometallurgical treatment to remove other metals and impurities. During the drossing stage, lead bullion is cooled in a kettle until a dross forms on the surface. The dross, containing lead oxide and other metals, is skimmed off and treated elsewhere to recover the metals. The lead bullion is further refined by adding various reagents at different stages to remove specific metal impurities. The final pure lead can be cast into specific shapes or mixed with other metals to create alloys. Alternatively, lead refining can be carried out using an electro-refining technique, producing pure lead cathodes. It is not expected that significant emissions of mercury would occur during refining.

2.1.4 Sulfuric Acid Plant

Smelter or sintering plant off-gas is treated to remove particulate matter and most metals including mercury using gas cleaning devices such as scrubbers and electrostatic precipitators. If the gas still contains significant mercury, it then undergoes a mercury removal stage which removes the mercury as a waste. The waste containing mercury should be disposed of in an environmentally sound manner.

Following mercury removal, the gas contains a high concentration of sulfur dioxide which is usually converted into sulfuric acid in an acid plant. Any remaining mercury will be contained in the acid. However, commercial grades typically specify a mercury concentration of less than 1 ppm in the acid, so effective mercury removal is required prior to the acid plant. The emissions from the final stack are expected to contain trace concentrations of mercury.

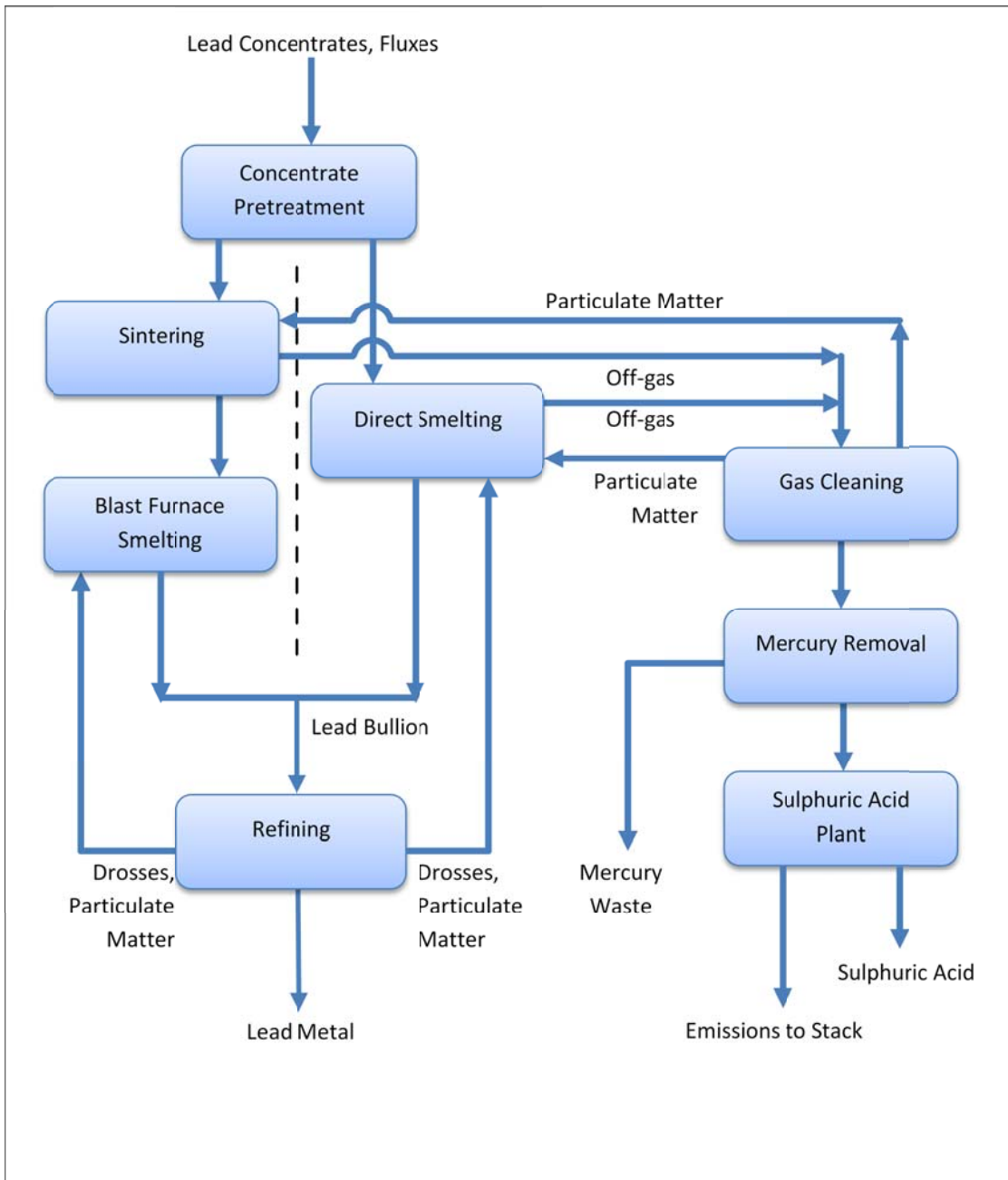

Figure 1: Schematic of processes in primary lead production

2.2 Process steps in zinc production

The primary zinc production process consists of five main stages: concentrate blending; roasting or smelting; leaching and purification; electro-winning; and melting and alloying. A schematic representation of the process is presented in Figure 2. Mercury is liberated mainly during the roasting process and must be captured to minimize mercury emissions from the final stack.

2.2.1 Blending, roasting and dust recovery

A schematic representation of the process steps in zinc production is presented in Figure 2. For commercial and logistics reasons, each zinc refinery will purchase zinc concentrates from several different mines. The mercury content from an individual mine can vary between 1 and 200 ppm. The key to smooth, environmentally managed and efficient operations is to ensure that all impurities, including mercury, are fed into the zinc process at a controlled rate. Blending is a well-established feed preparation process to mix concentrates of different quality. This prevents unexpected surges of impurities that can cause process or environmental upsets or lead to product quality problems.

Zinc concentrates are roasted by injection into a fluidized bed furnace at 950 °C where sulfides are transformed (roasted) into oxides and SO₂ gas. To avoid diffuse emissions, the furnace is operated under negative pressure. Virtually all mercury compounds present in the concentrates will vaporize in this furnace. Dust, also called particulate matter, is recovered from the gas stream. This dust goes to the leaching section, along with the zinc oxides from roasting. The gas flows to the gas cleaning stage.

Alternatively, in the Imperial Smelting process, zinc concentrates or bulk concentrates containing zinc and lead are first roasted and sintered, then smelted in an Imperial Smelting Furnace (ISF) (Morgan 1968).

2.2.2 Gas cleaning

In the wet gas cleaning the last traces of dust are removed using particulate matter abatement devices, such as scrubbers and electrostatic precipitators. Wastewater from this gas cleaning contains mercury and other heavy metals and is treated in a wastewater treatment plant or is injected into the roasting furnace to maximize mercury collection via the dedicated mercury removal process. Different types of mercury removal processes exist and are described below. These specific mercury removal units reduce mercury concentrations to low levels. The output of this mercury removal process is a mercury concentrate. About 50 to 90 per cent of the total mercury input ends up in this concentrate.

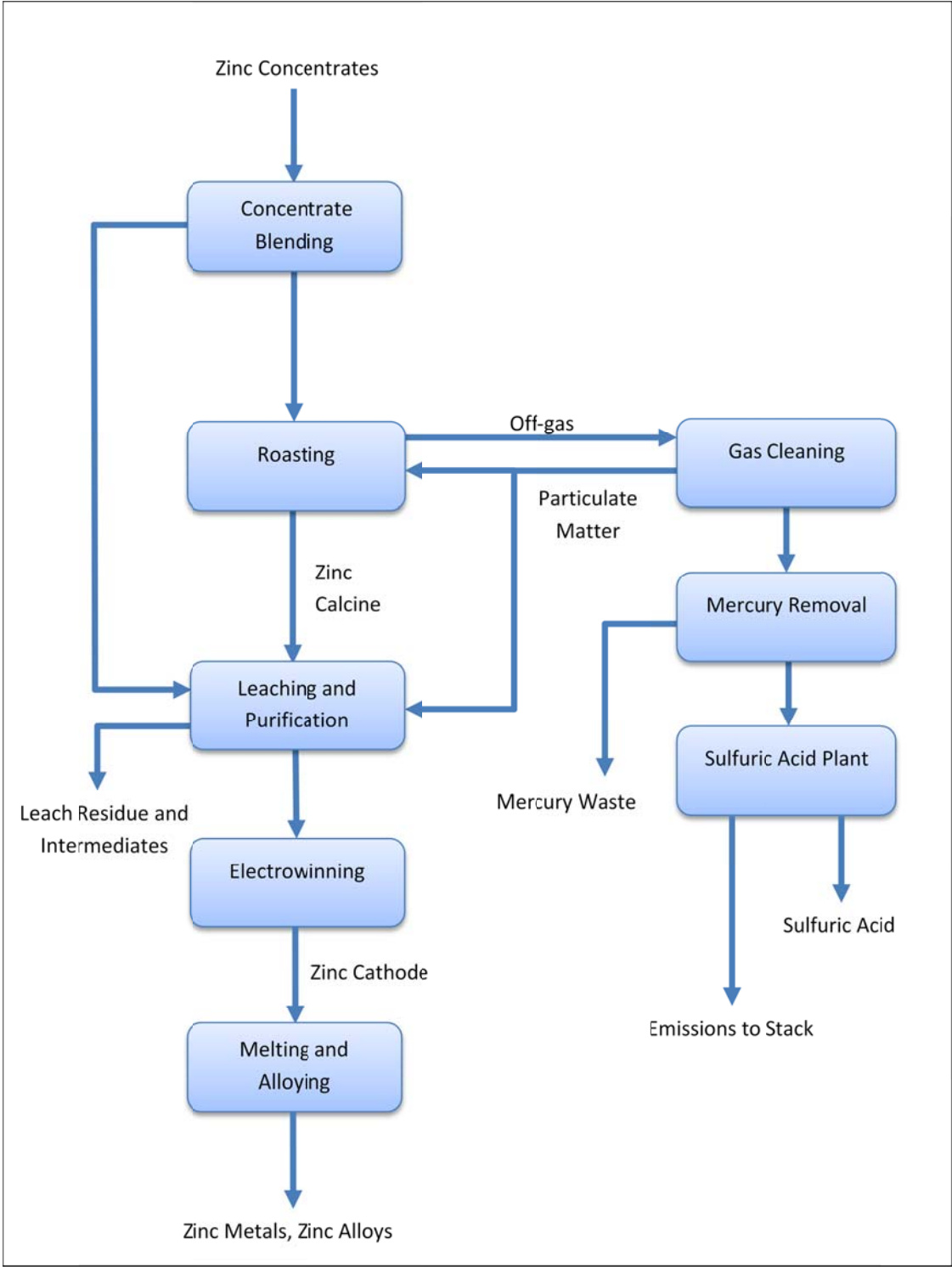

Figure 2: Schematic of processes in primary zinc production

2.2.3 Sulfuric acid plant

After mercury removal, the SO₂ from the gas is transformed into sulfuric acid. Approximately 90% of the residual mercury in the gas stream will be trapped in the acid. To comply with commercial grades of sulfuric acid, mercury concentration in the acid should be less than 1 ppm. Less than 2% of the total mercury input ends up in the sulfuric acid. The mercury emission from the stack where controls are in place is typically less than 0.1 ppm or less than 100 µg/Nm³ and represents less than 0.25% of the mercury input.

2.2.4 Leaching

In the leaching step the oxidized zinc concentrate ('zinc calcine'), is dissolved in acid. The solution is purified by cementation on zinc metal dust (powder), containing no mercury and sent to the electrolysis plant to recover zinc metal. Other metals e.g. copper, cadmium, lead, silver, cobalt, nickel are recovered in separate fractions and further refined in other plants. A final leach residue, containing mainly iron in the form of jarosite, goethite or hematite, lead sulfate and silicates can be disposed of as hazardous waste in an environmentally sound manner. Often, the leach residue, which may contain some mercury, is recycled to a lead smelting process.

In the leaching process, there may also be a direct feed of unroasted mineral concentrates which do contain mercury. The input of unroasted concentrates in the leaching process is typically about 10% of the total concentrate input but can increase up to 50 per cent when direct leaching is applied. Mercury from these unroasted concentrates ends up in the leach residue as a nearly insoluble mercury sulfide. Since mercury is not dissolved, there is no emission to air in the leaching process. Depending on the amount of unroasted concentrate present in this process step, about 5 to 50 per cent of the mercury input will end up in this leach residue.

2.3 Process Steps in Copper Production

Primary copper can be produced by pyrometallurgical or hydrometallurgical processes. Approximately 20-25 per cent of primary copper is produced by hydrometallurgical technologies such as leaching of oxide type ores. The remainder of primary copper production uses the pyrometallurgical process. Since the hydrometallurgical process does not involve roasting or smelting, these processes are not covered by Annex D of the Minamata Convention and are, therefore, beyond the scope of this guidance document.

The copper ores that require processing through the pyrometallurgical process are sulfidic. When the pyrometallurgical process is used, any mercury present in the concentrate will be liberated primarily during concentrate smelting and matte converting into the process gas. Depending on the temperature of the dryers used, mercury may also be emitted during the drying process, for facilities which utilize a concentrate dryer.

A schematic representation of various parallel pyrometallurgical processes in copper production is presented in Figure 3:

- Roasting, smelting and converting
- Smelting and converting
- Direct to copper smelting

2.3.1 Concentrate Drying

The pyrometallurgical process starts with the blending of concentrates and fluxes to produce a stable and homogeneous feed, especially when processing concentrates with varying concentrations of copper or impurities. For flash smelting vessels, the blended concentrates then undergo drying to reduce moisture content. At this stage the concentrate is dried to 0.2 per cent moisture, usually using rotary, “multicoil” or fluidized bed dryers, operating at an outlet temperature ranging from of 100-200° C. Dry concentrate is then sent to smelting vessels. Dust from the dryer process gas is removed in bag houses or electrostatic precipitators. For facilities using IsaSmelt or similar technologies, the concentrate blend is not dried prior to introduction to the smelting vessel and conversion to a molten matte/slag mixture.

2.3.2 Roasting

Older technologies may still be used where concentrates are roasted prior to smelting. In facilities conducting this process, the blended concentrates are first roasted to convert the copper sulfides to oxides before treatment in the smelter. The roasting process gas, which contains sulfur dioxide and some mercury, is treated using scrubbers or electrostatic precipitators to remove particulate matter. The gas is then sent to the acid plant.

2.3.3 Smelting

Once dried, the blend of concentrates and fluxes is smelted to produce a matte (or less frequently to blister copper), usually in an oxygen-enriched atmosphere in a smelting furnace. Several types of copper smelting processes exist which include flash smelting and bath smelting. Another process, not shown in Figure 3, involves a multi-furnace continuous smelting and converting stage, which produces blister copper.

In particular, flash smelting is widely used, as it is an efficient technology whereby the heat released from the oxidation of the sulfide minerals drives the smelting process. In addition to producing the matte (or less frequently blister copper), the smelting produces a slag. The operating temperature of the furnaces is 1230-1250 °C. At this temperature, elemental mercury and mercury sulfide compounds will be completely volatilized. The process gas is captured and sent to the gas cleaning system.

2.3.4 Converting

For smelting processes that produce a copper matte, the matte is then transferred to the next stage in the process: converting of matte or copper alloy (produced from the cleaning of ‘direct to blister’ smelting slag) to blister copper. A by-product of this process is the production of converter slag, which is reprocessed to recover copper in a slag cleaning furnace or returned to smelting. Process gas generated from the converters undergoes particulate matter removal and is finally mixed with the gases from the smelting furnace before entering the gas cleaning system of the sulfuric acid plant.

2.3.5 Refining & Casting

Blister copper is then refined in anode furnaces, mainly to eliminate oxygen and any contaminants. The process gas generated in the anode furnaces is treated in a wet scrubber and then in a wet electrostatic precipitator or in a baghouse. Refined copper is cast into anodes. The final stage of copper production is electro-refining of anodes to copper cathodes containing more than 99.995 per cent of copper.

the

furnace

trace

oxygen, sulphur and
trace contaminants

2.3.6 Slag Cleaning

The molten slag produced in the smelting furnace and converters may be treated in an electric slag cleaning furnace to recover copper and other valuable metals contained in the slag. This produces a high grade matte which is transferred to the converters. The final slag may be granulated with water. The slag is either sent for disposal or used as an aggregate material.

In processes conducting direct smelting to blister copper, slag cleaning can produce copper alloys, which are sent to the smelter for reprocessing in converters.

Alternatively, instead of treatment in a slag cleaning furnace, slag cleaning can be carried out using mineral processing techniques. After slow cooling, the slag is crushed, milled and processed through flotation. A concentrate containing copper is produced and returned to smelting.

2.3.7 Sulfuric Acid Plant

Smelting and converting process gases are directed to the gas cleaning section of the sulfuric acid plant. The process gas is first cooled and treated to remove particulate matter, metals and acid mist using gas cleaning devices such as scrubbers and wet electrostatic precipitators. During gas cleaning, the gas is cooled down to 35-40 °C. Most of the mercury coming from the smelter is removed at this stage by the three following mechanisms:

- A portion of the mercury reacts to form solid mercury sulfate, which is removed as a sludge.
- Elemental mercury is condensed by rapid quenching and cooling in scrubbers and packed cooling towers.
- Selenium present in the copper concentrates is liberated in the smelting and converting processes and is contained in the smelter process gas as selenium oxide. Selenium oxide dissolves in the weak acid scrubbing solution and it is immediately reduced by sulfur dioxide to form “red” selenium which reacts with the elemental mercury to form solid mercury selenide (HgSe). Mercury selenide is a compound of extremely low solubility in water, stable in acidic conditions. The gas phase selenium is also reactive with mercury in the process gas stream due to the higher temperatures and abundance of sulfur dioxide.

Following gas cleaning, specific mercury removal technology may be required before acid production to remove any remaining mercury in the process gas to meet commercial standards. The emissions from the final stack are expected to contain trace concentrations of mercury. Mercury-containing residues and sludges resulting from gas cleaning or mercury removal processes should be disposed of in an environmentally sound manner.

treated and recycled or



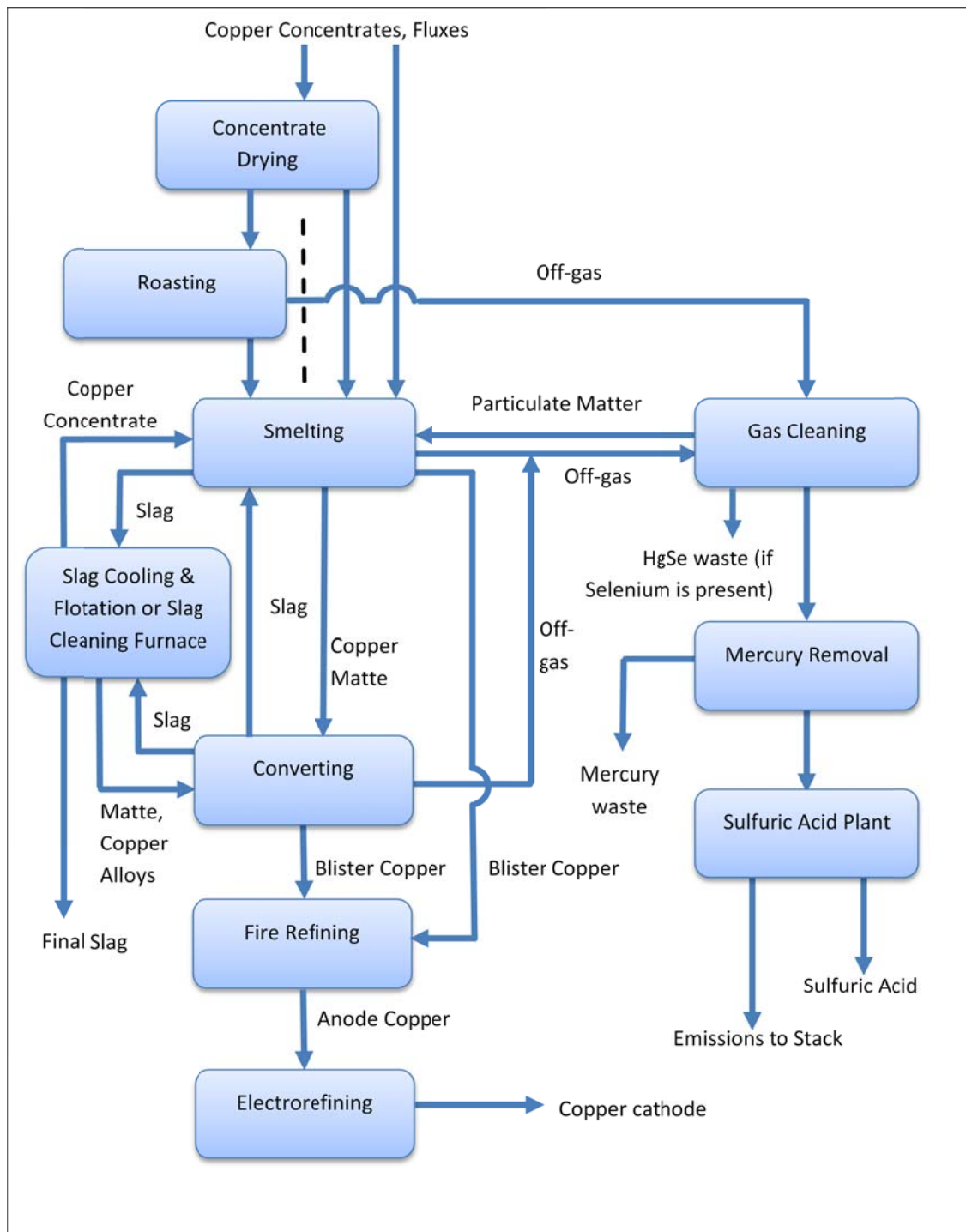

Figure 3: Schematic of processes in primary copper production

2.4 Process Steps in Gold production

Some gold ores require pre-treatment before leaching while other ores can be leached directly. This section will focus on those ores that require roasting as a pre-treatment to leaching since Annex D to the Minamata Convention covers roasting. An overview of the processes involved is given in Figure 4.

2.4.1 Roasting

Ground gold ore, typically containing mercury at 0 to 100 ppm, is fed into the roaster. Roasters operate at 500-600°C, the heat being used to oxidize both the sulfur and the carbon from the ore so that the gold can be leached and recovered. The elevated temperatures cause the mercury contained within the ore to be volatilized. The gases produced from the roasting process are treated through several steps, some of which are co-pollutant controls, as well as specific unit processes that are applied to minimize mercury emissions to the greatest extent possible. These controls are described in greater depth in the case study presented separately. Overall mercury removal from the roaster off-gas is expected to be greater than 99 per cent based on installations of similar controls at existing commercial operations.

2.4.2 Leaching

Water is added to the roaster discharge into an agitated tank where the water and solids from the roaster are mixed, creating a slurry. This slurry is sent to a series of tanks where gold is leached from the slurry (Carbon-In-Leach (CIL) circuit) using cyanide. Once dissolved, gold complexes adsorb from the slurry solution onto activated carbon. Mercury complexes also adsorb onto activated carbon. The final slurry, now depleted of gold and mercury, is treated in a neutralization and detoxification process and then discharged to the tailings impoundment facility as waste. The cyanide soluble mercury that remains in the tails solution from leaching will be a very small contributor to atmospheric mercury due to the very low vapor pressure of the cyanide mercury complex.

2.4.3 Stripping and Regeneration

The loaded carbon from the CIL circuit is washed and then transferred to a vessel where gold and mercury are stripped from the carbon back into solution. This results in a solution that is high in gold content from which the gold can be extracted by electrowinning or precipitation as described below. After removing the gold from the carbon (stripping), the carbon is sent to a kiln for thermal regeneration and recycled back to the leaching stage.

Some adsorbed mercury remains on the stripped carbon. The carbon regeneration kiln is an enclosed vessel which heats the carbon to a temperature above 700 °C, drying the carbon and removing any remaining adsorbed mercury into a gaseous form. The vessel does not contain oxygen which allows the carbon to be dried without oxidizing or burning the carbon. The gas is vented and cooled; elemental mercury is condensed out and collected in fully-contained industrial flasks for environmentally sound disposal. Any remaining gaseous mercury is then passed through a vessel with sulfur-impregnated activated carbon. The mercury in the gas chemically binds with the sulfur to form a stable cinnabar compound (mercury(II) sulfide).

Overall mercury removal from the carbon regeneration kiln vent gas is anticipated to be greater than 99 per cent based on experience with similar controls at other existing commercial operations. While carbon regeneration kilns are beyond the scope of Annex D of the Minamata Convention, it is

important to note that they may, in instances where emissions are not controlled, be significant sources of mercury emissions.

2.4.4 Refining

The gold sludge from electrowinning or precipitation using zinc dust is filtered and then processed in a retort vessel. The retort heats the sludge above 600 °C to dry the solids and any mercury is removed in the vent gas. Retort gas is vented to gas-handling equipment to remove the mercury before the gold-bearing material is sent to the refining furnace. The retort gas is first cooled and condensed, collecting mercury in an elemental form. Any remaining mercury that was not condensed is then passed through a vessel containing sulfur-impregnated activated carbon. The mercury in the gas chemically binds with the sulfur to form a stable cinnabar compound. Overall mercury removal from the retort vent gas is anticipated to be greater than 99 per cent based on installations of similar controls at an existing operation.

2.4.5 Furnace

The dried gold-bearing solids from the retorts are heated in a furnace to temperatures above the melting points of all the constituents in the charge to provide the final separation of gold from impurities. The vent gas is first passed through a bag house to remove any particulate matter including particulate-bound mercury. The vent gas is then passed through a vessel containing sulfur-impregnated activated carbon where the mercury chemically binds with the sulfur to form a stable cinnabar compound. Overall mercury removal from the furnace vent gas is anticipated to be greater than 99 per cent based on installations of similar controls at other existing operations. The waste containing mercury should be disposed of in an environmentally sound manner. For purposes of clarification, it is noted that emissions from the furnace are not covered by Annex D of the Minamata Convention. Further, furnaces are not likely to be more than minor sources of mercury emissions.

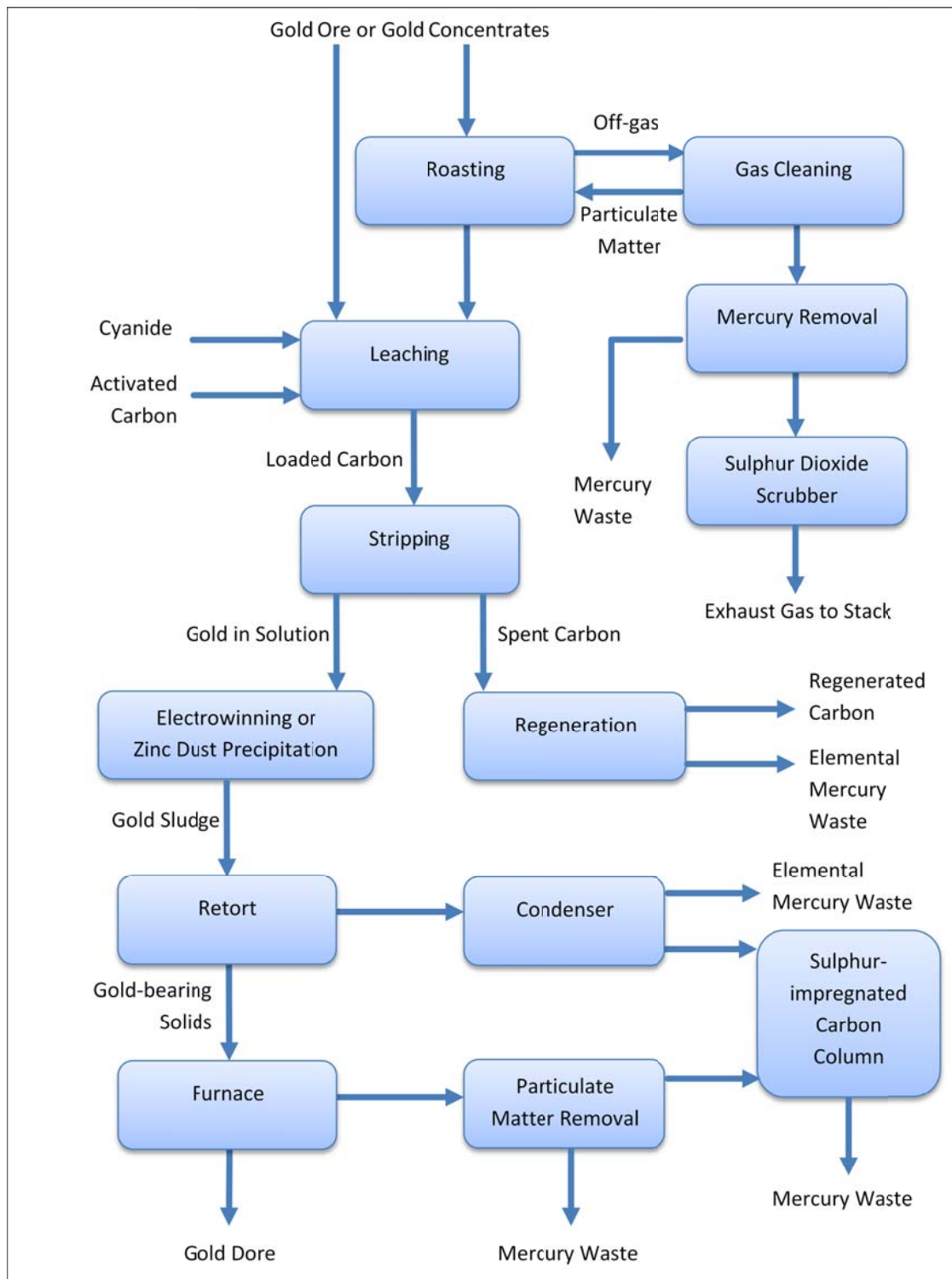

Figure 4: Schematic of processes in primary gold production

3 Emission control techniques

In the following sections the main mercury air emission abatement techniques relevant to the non-ferrous roasting and smelting and refining sector are described. In general these rely on some form of mercury oxidation and interactions with materials such as mercury(II) chloride. This list does not include those techniques that are recognized to reduce mercury emissions to air by virtue of the co-benefit of capture of other pollutants – such as organic carbon compounds or other particulate matter. A cross-cutting section on multi-pollutant control technologies that provide a co-benefit for mercury emissions capture is also presented.

Mercury is volatile at the temperatures encountered in most abatement processes, and hence sector-specific techniques may be needed to remove it. In the case of mercury removal before a sulfuric acid plant, any residual mercury will be present in the acid that is produced. The quality of acid is often defined in terms such as commercial grade, technical grade, electrolytic grade, battery grade, food grade, etc. These terms are general in nature and may differ from supplier to supplier and from country to country. The product specification depends on the potential use of the acid and has been reported to be typically less than 1.0 ppm and “equivalent to ~ 0.02 mg/Nm³ in the cleaned gas”¹, although for some applications significantly lower concentrations may be required².

3.1 Boliden Norzink process

3.1.1 Description

The “Boliden Norzink process” (also called the “Outotec chloride scrubber process” or as the “Outotec BN Process”³) removes elemental mercury from waste gases of primary ore smelters by converting mercury into mercury(I) chloride, Hg₂Cl₂ (“calomel”). Calomel results from the reaction of mercury with mercury(II) chloride, HgCl₂. Mercury(II) chloride is then recovered from some of the calomel by oxidation with chlorine and returned to the gas-cleaning process.

The process⁴ takes place in a packed bed tower. Vaporous elemental mercury contained in the waste gas is oxidized by a water based scrubber solution of mercury(II) chloride:



The tower consists of a vertical fiberglass reinforced cylindrical vessel where the waste gas passes through from the bottom up. The tower is filled with a polypropylene packing (generally shaped like saddles). In the upper part of the tower the scrubbing solution is sprayed onto the top of the packing through a series of nozzles. A chevron or mesh pad mist eliminator at the outlet of the tower prevents escape of the scrubbing solution from the system. Process temperature is about 40 °C and lower. Pressure drop by the scrubber tower is about 1 kPa.

The resulting calomel is insoluble. It precipitates from the liquor and is removed at the bottom of the tower as dense slurry. The liquor is circulated back to the scrubber. Under optimized process conditions, elemental mercury reacts almost completely with mercury(II) chloride.

¹ www.mercuryconvention.org/Portals/11/.../EG1/EU_information.pdf Accessed 24th March 2015.

² http://www.sulphuric-acid.com/techmanual/Properties/properties_acid_quality.htm Accessed 24th March 2015.

³ <http://www.outotec.com/en/About-us/Our-technologies/Gas-cleaning/Mercury-removal/#tabid-2>

⁴ http://www.sulphuric-acid.com/techmanual/GasCleaning/gcl_hg.htm Accessed 24th March 2015

It is necessary to maintain a high mercury(II) chloride concentration in the circulated scrubbing solution to achieve an effective oxidization. Therefore, half of the slurry is treated with chlorine gas to re-oxidize the precipitated mercury(I) chloride into mercury(II) chloride:

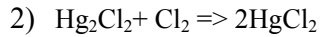

As soon as the treated calomel solution is completely regenerated, it is pumped into a storage tank. When the concentration of mercury(II) chloride in the scrubbing circuit depletes, regenerated mercury(II) chloride solution is added from the storage tank to maintain the concentration of mercury(II) chloride in the scrubbing circuit.

The net reaction of the process steps 1) and 2) is:

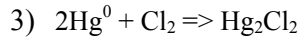

The second half of the calomel slurry is directed to a settler. The clarified solution overflows and is returned to the scrubbing tower pump tank. At the bottom of the settler, insoluble mercury(I) chloride settles into a conical tank. The solids pass to a second settler to concentrate further. Zinc dust can be added to support the precipitation. The solids resulting from the second settler are filled into storage drums for sale or for further internal processing. The calomel "bleed" can be finally disposed of or used for elemental mercury production. The mercury is then stored in secure storage vessels. Figure 5 shows a flow chart of the Boliden Norzink Process.

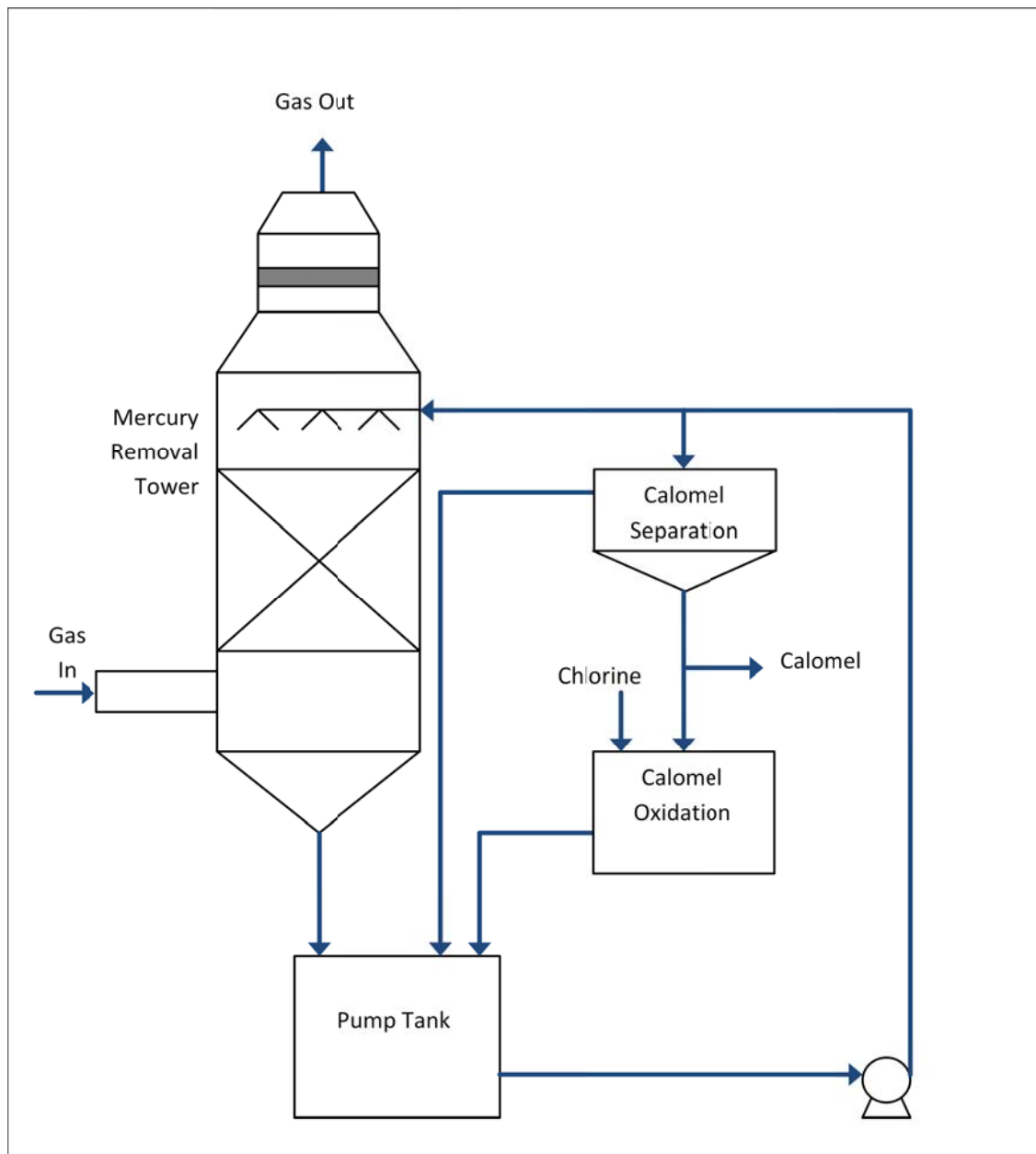

Figure 5: Flowchart of Boliden Norzink Process with Hg_2Cl_2 recovery (Hultbom 2003)

3.1.2 Applicability

This process is applicable to all process gases from ore smelters, in particular for process gases containing SO_2 . The technique is effective for varying input levels of mercury as well as for high mercury content. This process is used effectively in about 40 plants worldwide.

3.1.3 Performance

Removal efficiency depends on the mercury content of the waste gas inlet and is typically 99.7 per cent. Typical mercury outlet concentration is 0.3 - 0.5 ppm⁵ (Hultbom 2003; UNECE 2013). An outlet concentration of 0.3 - 0.5 ppm is also achieved with high mercury inlet concentrations exceeding 100 mg/Nm³ (Hultbom 2003)⁶.

Table 1: Performance of Boliden Norzink process at Boliden Rönnskar⁷ (BREF NFM 2014)

| Gas flow 30,000 Nm ³ /h | Before [$\mu\text{g}/\text{Nm}^3$] | After [$\mu\text{g}/\text{Nm}^3$] | Reduction efficiency [%] |
|------------------------------------|--------------------------------------|-------------------------------------|--------------------------|
| High inlet concentration | 9879 | 30 | 99.7 |
| Low inlet concentration | 51 | 13 | 74 |

3.1.4 Cross-media impacts

- Impacts on air and water due to the production of solid calomel waste, by leaching or vaporization of mercury. Calomel waste needs to be stabilized before environmentally sound disposal (e.g. in underground salt mines).
- Risk to workers' health from potential exposure to mercury(II) chloride or chlorine (highly toxic).

3.1.5 Costs of installation and operation

Due to the low process temperature (less than 40°C), mainly plastic materials are used for the construction.

Operating costs are low as they are restricted to:

- electric energy consumption for circulating pumps,
- increased electric energy consumption for fans to compensate the pressure drop created by the scrubbing tower,
- chlorine gas consumption for mercury(II) chloride recovery.

Operating costs are practically independent of the mercury level in the waste gas⁷ (Hultbom 2003). The process is known to be economically viable. At Aurubis Hamburg the investment costs for the installation of the mercury removal plant was up to 5 million Euro (including condenser, heaters, bag filter, injection system, absorber and fans) (BREF NFM 2014).

3.2 Removal by reaction with sulfuric acid

3.2.1 Description

A number of techniques for controlling mercury emissions from smelting and roasting have been developed based on reaction with sulfuric acid. The Bolkem process is located in the acid plant, and

⁵ <http://www.outotec.com/en/About-us/Our-technologies/Gas-cleaning/Mercury-removal/> Accessed 24th March 2015

⁶ Nm³ is a normal cubic metre and refers to gas measured at a pressure of 1 atmosphere and a temperature of 0°C

⁷ United Nations Economic Commission for Europe, Protocol on Heavy Metals, available at : http://www.unece.org/env/lrtap/hm_h1.html Accessed 24th March 2015

the removal is achieved by 99 per cent sulfuric acid. This acid comes from the absorption part of the acid plant and oxidises the mercury at ambient temperature. The resulting acid that contains mercury is diluted to 80 per cent and the mercury is precipitated as sulfide with thiosulfate. After filtering off the mercury sulfide, the acid is returned to the absorption stage. No acid is therefore consumed in the process.

Mercury may also be removed before the washing step in the acid plant⁸. Gas at temperatures of about 350 °C is washed counter-currently with 90 per cent sulfuric acid at about 190 °C in a packed bed tower. The acid is formed *in situ* from the SO₃ in the gas. The process is based on converting the elemental mercury in the gas into a sulfate. The acid is recirculated until the solution becomes saturated with HgSO₄ and precipitation begins. The crystals of HgSO₄ are then separated in a thickener. In addition to removing mercury, other contaminants in the gas will be removed in the scrubber. Mercury can be recovered by mixing the solids with calcium oxide, and then heating to distil away the mercury which can then be dealt with in accordance with the Convention.

dealt

Alternately mercury may be precipitated and the mercury sludge removed from the cooled acid, filtered and washed. Part of the acid is then recycled to the scrubbing step. In a revision to this process, mercury is removed from the gases by washing with a solution of selenium ions, and selenium metal is produced along with mercury(II) selenide.

A thiosulfate process has also been described by Schulze (2009). In this process the absorption efficiency of mercury depends on the acid strength and acid temperature. The lower the acid temperature and the higher the acid concentration, the higher is the absorption efficiency. To avoid an accumulation of mercury in the product acid it is essential to absorb the mercury vapor in a two stage drying tower unit running with different acid concentrations in which the acid concentration in the second drying tower is higher than the acid concentration of the downstream absorption units.

The mercury containing acid of the drying towers has to be cleaned before discharging into the absorption circuits. Therefore the acid streams are gathered and treated in reaction units with sodium thiosulfate (Na₂S₂O₃·5H₂O).

The total amount of acid of both drying towers is stripped with air in a stripping tower to remove the dissolved sulfur dioxide. The stripped acid is discharged to a reaction tank in which a solution of 40% sodium thiosulfate and a filter aid medium are added. Sulfur is formed according to the reaction:

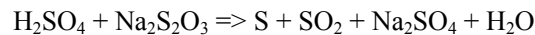

The sulfur reacts with the mercury in the acid to form mercury(II) sulfide, which precipitates. The temperature in this stage is about 50 °C and the acid concentration is about 80 weight per cent. The treated acid overflows to a maturing tank in which the reaction is completed.

These processes have been included in this section on BAT. However, it is not clear how many smelters or roasters are currently using these processes making their inclusion as BAT problematic.

⁸ http://www.sulphuric-acid.com/techmanual/GasCleaning/gcl_hg.htm; accessed 16th April 2015

3.3 Selenium filter

3.3.1 Description

The selenium filter process^{3,4} removes low elemental mercury content from waste gases of primary ore smelters by converting selenious acid into red amorphous selenium reacting with gaseous mercury to form mercury(II) selenide.

The selenium filter is a fixed bed filter with a large surface area, to achieve an intimate contact with the active substance. A porous inert material similar to a catalyst support is used. This material is impregnated with red amorphous selenium. The impregnation is achieved by drying selenious acid to precipitate red amorphous selenium:



The red amorphous selenium reacts with the mercury in the gas to form mercury(II) selenide:

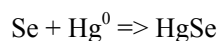

The contact time in the filter is about 1 to 3 seconds.

The filter continues to be effective until the level of mercury in the filter reaches 10-15%. The filter is then treated to recover the mercury and regenerate the selenium.

The vapor pressure of mercury at temperatures of 0-100 °C is very low compared to HgSe. Selenium is well suited as a control substance as its vapor pressure is also very low at these temperatures, and selenium losses are minor. The filters can operate at temperatures up to 110 °C with water vapor saturated gases. However, condensation inside the filters should be avoided.

The pressure drop is of the order of 600 Pa for a one stage filter with a 3-second retention time.

The selenium filter can produce virtually mercury-free waste gases from ore smelters. It can also be applied as a second waste gas treatment step to lower the mercury content before the gas enters a subsequent acid plant producing mercury-free acids.

Compared with other fixed bed mercury adsorbents such as activated carbon, a selenium filter has the advantage of reacting selectively with mercury. Unwanted side reactions will not occur as the selenium mass has no known catalytic activity. This makes it possible, for example, to use the selenium filter for mercury removal in moist SO₃ containing gases. With activated carbon, SO₂ will be oxidized to SO₃, which combines with water vapor to form sulfuric acid, clogging the filter (Hultbom 2003).

Alternatively, to achieve mercury concentrations of 0.05 mg/Nm³ and less, extreme gas cooling to temperature levels well below 0 °C would be needed to separate particulate mercury compounds and liquid mercury. The same residual level can be achieved by collecting mercury as mercury(II) selenide (HgSe) at temperatures up to approximately 140 °C (Hultbom 2003).

3.3.2 Applicability

The applicability is proven in at least 6 plants worldwide.

3.3.3 Performance level

Removal efficiency depends on the retention time. To achieve removal efficiencies of 95 per cent, a retention time of 3 seconds is normally needed (Hultbom 2003). Typically, removal efficiencies of 90 per cent are achieved⁴. Minimum expected hourly average mercury outlet concentration⁷ is less than 0.01 mg/Nm³. (UNECE Heavy Metals Protocol 2013). The following tables show typical mercury reductions.

Table 2: Performance of selenium filter process at Boliden Rönnskar⁷ (copper-lead-zinc smelter) (BREF NFM 2014)

| Gas flow 80,000 Nm ³ /h | Before [$\mu\text{g}/\text{Nm}^3$] | After [$\mu\text{g}/\text{Nm}^3$] | Reduction efficiency [%] |
|------------------------------------|--------------------------------------|-------------------------------------|--------------------------|
| High inlet concentration | 1008 | 48 | 95 |
| Low inlet concentration | 42 | 12 | 71 |

Table 3: Typical results of selenium filter process (Hultbom 2003)

| Gas flow | Before [$\mu\text{g}/\text{Nm}^3$] | After [$\mu\text{g}/\text{Nm}^3$] | Reduction efficiency [%] |
|--------------------------|--------------------------------------|-------------------------------------|--------------------------|
| High inlet concentration | 6000 | <50 | 99 |

3.3.4 Costs of installation and operation

The investment cost is proportional to the amount of gas flow.

When the selenium mass is saturated with mercury it must be replaced. This represents the major cost for this technology, and it is basically proportional to the quantity of mercury removed (Hultbom 2003).

Costs for installation of the selenium filter are often compared with those for the Boliden Norzink process in situations where they are the most appropriate technologies. At lower gas flow rates the relative investment cost is higher than those for the Boliden Norzink process, as it is a scrubbing method which requires more equipment. Conversely the opposite is true for higher flow rates as the scale-up cost for a scrubber is smaller than for a fixed bed filter (Hultbom 2003).

For higher gas flow rates with high incoming levels of mercury the Boliden Norzink process is the more economical; however, it has been reported that to meet the most stringent demands for mercury removal it is possible to combine the Boliden Norzink process and the selenium filter (Hultbom 2003).

Industry sources report indicative costs for a selenium filter with 200,000 m³/h capacity of an initial investment of about 3 M Euros plus 70 ton of selenium at a price of 35,000 Euros/ton.

3.3.5 Cross-media impacts

There are potential impacts on air and water due to vaporization of elemental and/or oxidized mercury from the production of solid mercury(II) selenide waste. The waste needs to be stabilized before environmentally sound disposal.

recycling or

3.4 Activated carbon filter

3.4.1 Description

Sulfur-impregnated activated carbon⁹ is a proven technology that is used in the industrial gold sector to control mercury air emissions. Activated carbon can be applied in either a fixed bed setting or through carbon injection. Mercury contained within the gaseous emissions reacts with the sulfur-impregnated carbon as it passes through the bed forming mercury(II) sulfide (HgS). Activated carbon has the advantage of removing all types of mercury air emissions including oxidized, particulate-bound and elemental mercury.

This control technology captures mercury as stable mercury sulfide (HgS) absorbed within sulfur-impregnated active carbon. It is at an advanced level of development. It is a proven technology and commonly used in the non-ferrous sector with significant application in the gold mining sector as well as some use in other metals. It is also commonly used in the power industry.

When a source uses activated carbon, it will need to deal with some limitation. First, the maximum operating temperatures vary by manufacturers. There may be a need to pre-cool the gas stream. Second, if the gas stream has greater than 10 per cent moisture, pre-treatment is required to reduce moisture. Finally, there is a risk of fire associated with the use of activated carbon as a mercury control; however, many facilities have been using activated carbon without incident for many years. With proper management, these risks can be mitigated and minimized.

3.4.2 Applicability

Activated carbon can be used to remove all forms of mercury emissions: gaseous and particulate, elemental and oxidized. It is able to adsorb from 10-40 per cent by weight of mercury before it is required to be replaced. Further, sulfur-impregnated carbon (15-20 per cent by weight) is efficient in forming a stable sorbent.

3.4.3 Performance level

A properly designed and maintained sulfur-impregnated carbon adsorption system located downstream of a condenser is able to capture 99 per cent of the mercury achieving a concentration of 0.01 mg/m³. Carbon manufacturers' mercury adsorption specifications vary from 10-40 per cent. However, the carbon is typically loaded with mercury to 20 per cent by weight before replacement. Spent adsorbent is disposed of as hazardous waste or retorted to recover the elemental mercury which is then sent for environmentally sound disposal.

3.4.4 Costs of Installation and Operation

A driver for capital cost is the volumetric gas flow rate to be treated. Figure 6 summarizes equipment and materials for a system involving, scrubbing, cooling, condensing, and carbon adsorption beds. The cost of construction / installation is not included given the variability due to geography and the complexity of the associated projects.

⁹There are other types of activated carbon including halogen-, fluoride-, iodine-, and bromine-impregnated activated carbon that are also being used for mercury control but it is unclear whether the non-ferrous sector is actively using these types of activated carbon. These types may more appropriately belong in our section on emerging technologies. Therefore, the focus of this paper is on sulfur-impregnated carbon.

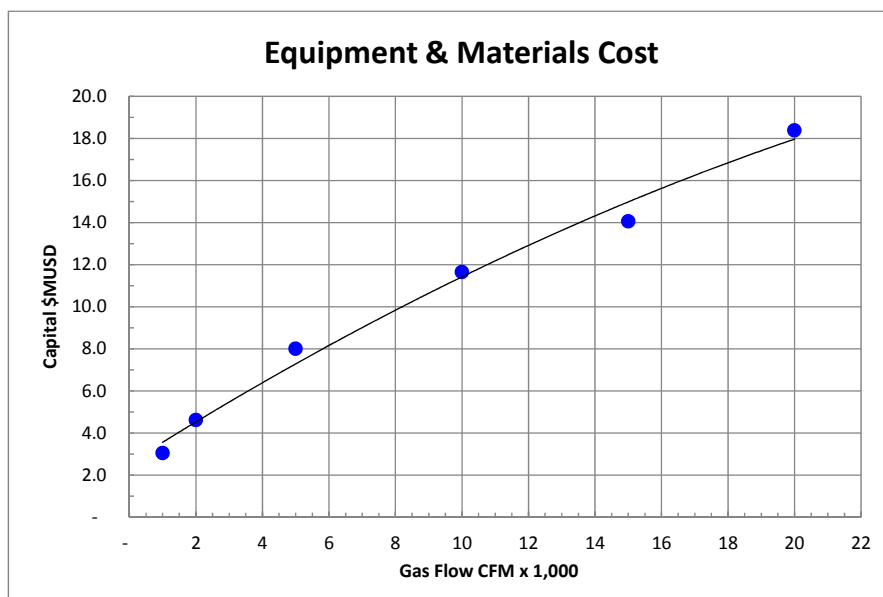

Figure 6: Capital cost of equipment and materials for sulfur impregnated activated carbon filters as a function of gas flow (CFM: cubic feet per minute)

The main cost of operation is replacement and disposal/retorting of the spent sulfur-impregnated activated carbon. The rate of replacement is driven by the mercury content within the gas flow. The replacement cost of sulfur impregnated carbon in North America is \$ 6.6 (USD)/ kg.

3.4.5 Co-Benefits

Activated carbon which is not sulfur-impregnated is very effective at removing organic compounds, such as dioxins/furans and Volatile Organic Compounds (VOCs) contained within the gas stream. If organic compounds are present, an “activated carbon pre-cleaning bed” is commonly installed to remove them ahead of the sulfur-impregnated bed intended for mercury. Without the pre-cleaning bed, organic compounds would adsorb onto the sulfur-impregnated carbon reducing capacity for subsequent mercury removal and increasing costs due to more frequent bed replacements.

3.4.6 Cross Media Impacts

Spent mercury loaded sulfur-impregnated carbon may require disposal as hazardous waste. Either the spent carbon should be sent directly for disposal as a hazardous waste or retorted to recover elemental mercury which should then be disposed of as a hazardous waste.

3.5 The DOWA filter process (lead(II) sulfide covered pumice filter)

The lead(II) sulfide process is a dry media technique used to remove mercury from flue gases generated in non-ferrous metal smelters. The gases containing volatile mercury are passed through a tower packed with lead-sulfide-coated balls, such as granulated pumice, to make the gas contact effectively. Mercury, which has a high vapor pressure, is converted into its sulfide, which shows very low vapor pressure, by contacting the gas with lead(II) sulfide. For the lead(II) sulfide process, a mercury removal efficiency of 99 per cent has been measured, resulting in mercury emission concentrations of 0.01-0.05 mg/Nm³.

Indicative costs have been obtained from industry sources: a Dowa tower with 200,000 m³/h gas capacity has an initial investment cost of about 5.5 million Euros, plus the cost for 500 m³ of the filter materials of 1800 Euros/ton, and has a lifetime of approximately 5 to 10 years.

3.6 Co-benefits of common air pollution abatement technologies and acid plants in mercury control

3.6.1 Pollution Abatement Technologies

A cross-cutting section on common pollution abatement technologies that provide a co-benefit for mercury emissions capture is presented in Section 1.7.2 of the chapeau document. The current section discusses the applicability of those techniques to the non-ferrous metals sector.

3.6.1.1 Bag filters

The use of bag filters is common in the non-ferrous metals sector as this technique provides the highest collection efficiency among the particulate control methods. The dust cake collected on the filters can be removed periodically using methods such as reverse airflow, mechanical shaking, vibration and air pulsing. The dust cake can then be recycled in the smelter process to recover any metals of value. This technique is effective in capturing mercury in particulate form, or mercury that has adsorbed onto particles.

3.6.1.2 Electrostatic precipitators

Both wet and dry electrostatic precipitators (ESPs) are widely used in the non-ferrous metals sector as a primary stage of particulate matter removal. In dry ESPs, the dust that collects on the charged plates is removed by rapping or vibration. The dust is usually recycled in the smelter process.

In wet ESPs, the dust is removed by flushing the plates, usually with water. An effluent and sludge are produced, which can be recycled in the process if they contain valuable materials, or disposed of. Under certain circumstances, wet ESPs have been shown to effectively remove mercury in both gaseous and particulate form when operated in combination with other techniques such as scrubbers and gas coolers.

3.6.1.3 Scrubbers

The non-ferrous metals sector regularly uses wet scrubbers, such as for cooling gases and removing particulate matter as part of the gas cleaning process prior to sulfuric acid production. This technique produces an effluent and sludge. The effluent can be reused in the scrubber, while the sludge can be recycled in the smelting process or disposed of.

Wet scrubbers are effective in removing mercury in particulate form, or mercury that has adsorbed onto particles. However, wet scrubbers are not very effective in removing gaseous elemental mercury from gas streams, unless the appropriate disposal of this material should be considered when the other options would not be feasible.

3.6.2 Combine acid plants

3.6.2.1 Description

The combination of gas cleaning equipment with sulfuric acid plants is a proven technology for sulfur

or secondary

, treated and recycled off-site

or dilute sulfuric acid

The appropriate disposal of this material should be considered when the other options would not be feasible.

emissions control in the non-ferrous metals industry and their use is common worldwide. Under certain conditions, operation of an acid plant with gas cleaning equipment has also been shown to effectively capture mercury from the gas stream through the use of traditional particulate matter control techniques that result in mercury removal efficiencies equivalent to the use of specific mercury BAT. In these cases, where the ore properties and process conditions permit, almost all of the mercury is removed in the gas cleaning before the acid plant and residual mercury is removed from additional gas cleaning after materials are sent to the acid plant.

A recent survey¹⁰ completed in Japan has shown that many companies are successfully relying on gas cleaning and sulfuric acid plants to remove the mercury from the flue gases in metal smelting facilities. This study¹⁰ has shown that mercury is being effectively captured using this method at certain copper, lead and zinc smelters.

3.6.2.2 Applicability

Sulfuric acid plants combined with gas cleaning that effectively remove mercury have been implemented at copper, zinc and lead smelters worldwide.

An example of such a plant was provided in a detailed Japanese study (Takaoka *et al.* 2012) at an Imperial Smelting Process (ISP) zinc smelter which used a comprehensive mercury mass balance as illustrated in Figure 7.

3.6.2.3 Performance Levels

These results of the Japanese study show the potential effectiveness of the combined gas cleaning and sulfuric acid plant approach in capturing mercury. The total mercury concentration in the flue gases was found to be in the range 1.7–6.1 µg/Nm³ (Takaoka *et al.* 2012).

3.6.2.4 Costs

The combination of gas cleaning and sulfuric acid plants is standard technology for collecting sulfur dioxide from flue gas in smelters that process sulfidic concentrates. In cases where mercury can be recovered with this combination of technology at an efficiency equivalent to the use of specific mercury BAT, additional capital investment in mercury removal would not be required.

An additional CAPEX could be needed to meet sulfuric acid Hg specifications

¹⁰ [JMIA bulletin “Kozan (<http://www.mmf.or.jp/>) ” for the April 2015] Takashi Shimizu: Mercury Removal from the Nonferrous Smelter’s Off-gas in Japan

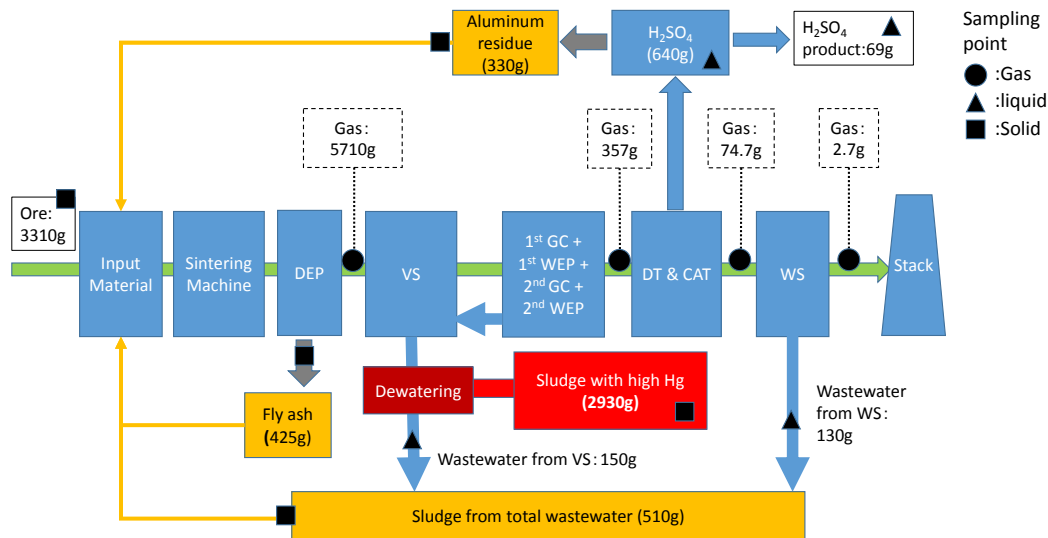

Figure 7: Mercury mass balance around sulfuric acid production at Japanese ISP zinc plant (Takaoka *et al.* 2012)

(DEP: Dry Electrostatic Precipitator, VS: Venturi Scrubber, GC: Gas Cooler, WEP: Wet Electrostatic Precipitator, DT: Dehydration Tower, CAT: Converting process and absorption tower, WS: wet scrubber)

3.6.2.5 Co-Benefits

Combined gas cleaning with a sulfuric acid plant is very effective at capturing sulfur-dioxide. In fact, the primary purpose for installing a sulfuric acid plant is the collection of sulfur dioxide and the production of saleable sulfuric acid.

3.6.2.6 Cross-Media Impacts

There are potential impacts on air and water due to the production of a solid mercury waste (sludge). This mercury waste should undergo environmentally sound disposal.

4 Emerging and Other Processes

treatment and recycling or

In this section mercury removal processes which are emerging or not widely in application are considered.

4.1 Selenium Scrubber

The selenium scrubber (Sundström 1975; Reimers *et al.* 1976; Coleman 1978; Habashi 1978) is a wet scrubber which uses the reaction between mercury and amorphous solid selenium in sulfuric acid. It is mainly used to remove high concentrations of mercury vapor. The acid concentration is maintained between 20 and 40 per cent. The acid concentration must be kept within these limits because complex and highly soluble selenium sulfur compounds are formed at low acid concentrations making it ineffective in reacting with the mercury in the gas. At higher acid concentrations, the oxidizing power of the acid will result in selenium dioxide or selenite being formed.

If the gas being treated contains sufficient selenium, there may not be a requirement to add selenium to the scrubber solution. The mercury reduction efficiency of a selenium scrubber is about 90–95 per

cent, resulting in mercury concentrations of about 0.2 mg/m³. However, at low incoming mercury concentrations the removal efficiency can be less than 90 per cent.

4.2 Jerritt process

4.2.1 Description

The “Jerritt process” is currently in use at one gold mine, and is illustrated in Figure 8. It removes elemental mercury from waste gases from the roasters by converting mercury into mercury(II) chloride, HgCl₂. Mercury(II) chloride results from the reaction of mercury with dissolved chlorine, Cl₂. A bleed stream containing mercury(II) chloride is then treated by direct electro-winning to recover elemental mercury, treated with zinc dust to precipitate mercury(I) chloride or returned to the thickener for recovery of any gold values.

The Jerritt process was developed and first installed in 2009 by the Canadian company *Yukon-Nevada Gold Corp.* at its Jerritt Canyon whole ore roasting facility (Elko, Nevada). Later, in 2010 the system was installed on its ore dryer.

The process takes place in a packed bed tower. Vaporous elemental mercury contained in the waste gas is oxidized by a water based scrubber solution of dissolved chlorine:

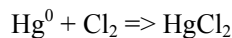

The tower consists of a vertical fiberglass reinforced cylindrical vessel where the waste gases pass through from the bottom up. The tower is filled with polypropylene saddle packing. In the upper part of the tower the scrubbing solution is sprayed onto the top of the packing through a series of nozzles.

A chevron mesh mist eliminator at the outlet of the tower prevents escape of the scrubbing solution from the system. Process temperature is about 40 °C and lower. Pressure drop through the scrubber tower is about 1 kPa.

The liquor is circulated back to the scrubber and a bleed stream equal to the volume of the pH controlling solution and the demister spray is removed from the recirculating solution. Under optimized process conditions, elemental mercury reacts almost completely with the dissolved chlorine.

4.2.2 Applicability

This process is applicable to all waste gases from roasters, in particular for waste gases where the SO₂ has been removed by scrubbing. The technique is effective for high input levels of mercury as produced by the Jerritt roasters as well as for low input levels of mercury as produced by the Jerritt ore dryer.

4.2.3 Performance

Removal efficiency is typically 99.97 per cent. Typical mercury outlet concentration is 0.004 - 0.005 ppm.

4.2.4 Cross-media impacts

- Impacts on air and water due to the production of solid calomel waste (avoided if electro-winning of mercury is applied to mercury(II) chloride or if the scrubber bleed is disposed of to the roaster thickener)

- Risk to workers' health from potential exposure to mercury(II) chloride (highly toxic).

4.2.5 Costs of installation and operation

Due to the low process temperature (less than 40°C), mainly plastic materials are used for the construction.

Operating costs are low as they are restricted to

- electric energy consumption for circulating pumps,
- increased electric energy consumption for fans to compensate the pressure drop created by the scrubbing tower,
- chlorine gas consumption.

Operating costs are practically independent of the mercury level in the waste gas.

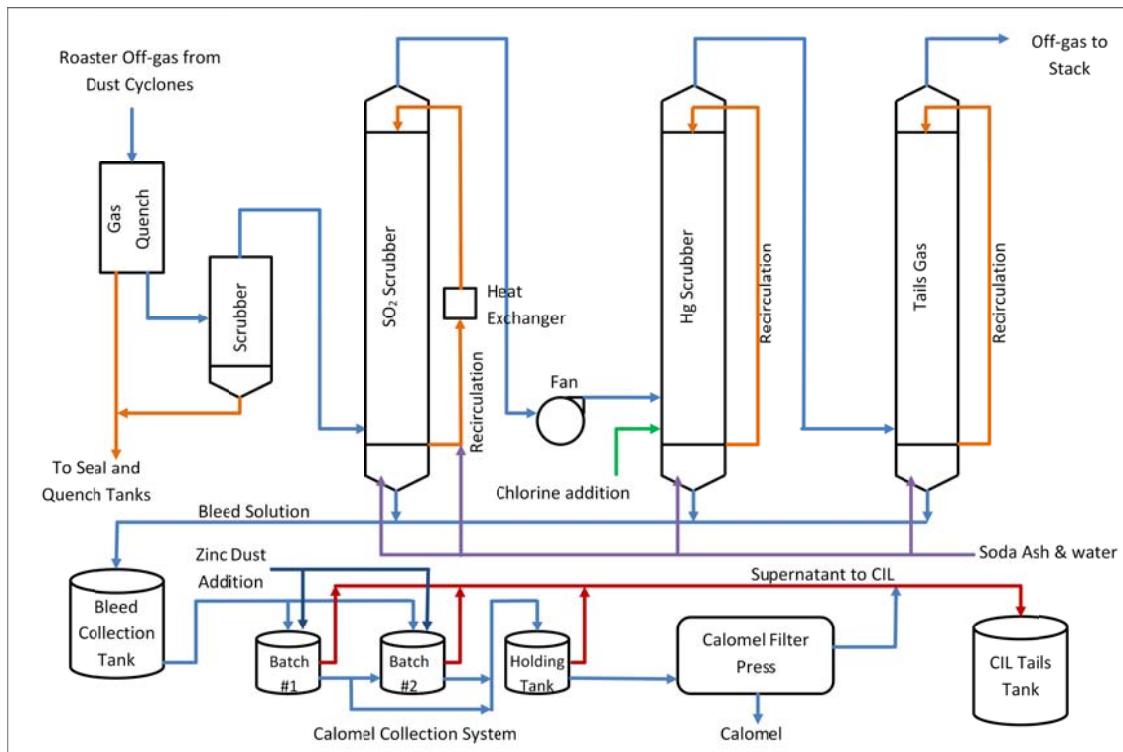

Figure 8: Flowchart of Jerritt Process with Hg_2Cl_2 recovery option

5 Best Available Techniques and Best Environmental Practices

5.1 BAT Overview

An overview of techniques that could be considered in identifying BAT for mercury reduction in the non-ferrous sector is given in Table 4. As described in Section 3.6 the co-benefits of gas and particulate pollution abatement techniques and acid plants may also achieve acceptably low emissions of mercury,

Table 4: Summary of mercury-specific control techniques for the non-ferrous metal smelting and roasting processes. *Typical emission performance is show and may not be demonstrative of all possible situations^{4,7} (UNECE 2013)

| Mercury Control Technique | Description | Typical Performance (Mercury efficiency) ^a | Advantages/ Comments | Disadvantages |
|--|--|---|---|--|
| Boliden-Norzink | Based on a wet scrubber using the reaction between mercury(II) chloride and mercury to form mercury(I) chloride (calomel), which precipitates from the liquor. | 99.7% - inlet concentration of ~ 9900 µg/m ³ 74% - inlet concentration 51 µg/m ³ | Widely demonstrated | Chlorine gas handling Calomel handling Calomel disposal as hazardous waste |
| Gas phase reaction with sulfuric acid (various processes) | Based on the use of sulfuric acid (from the acid plant) to oxidise mercury at varying temperatures. The resulting acid that contains mercury is diluted and the mercury is precipitated using thiosulfate and other reagents | | Unsure if this technique is currently in use | Not widely used Mercury containing material disposal as hazardous waste |
| Selenium filters | The selenium filter consists of a porous inert material soaked with selenious acid | 95% - inlet concentration | Especially suited to low mercury concentrations | Limited inlet mercury concentration Spent filter requires environmentally sound |

| | | | | |
|-------------------------------------|---|--|---|--|
| | which is then dried to precipitate red amorphous selenium. The red amorphous selenium reacts with the mercury in the gas to form HgSe. | 1000 µg/m ³ 71% - inlet concentration 42 µg/m ³ | in the gas Successful installation at metallurgical plants | disposal |
| Activated carbon filter beds | Activated carbon is well known for its adsorption properties. For the adsorption of mercury, activated carbon can normally adsorb 10-12 per cent of its own weight. | 97% - inlet concentration 1200 µg/m ³ 93% - inlet concentration 37 µg/m ³ | Sulfur-impregnated activated carbon is commercially available Removes Hg ⁰ and other species Low potential for leaching of mercury from spent carbon | Spent carbon requires disposal in landfill |
| DOWA | Based on the adsorption of mercury onto pumice stones coated with lead sulfide | 97% - inlet concentration 50 µg/m ³ 88% - inlet concentration 11 µg/m ³ | | Not widely used Mercury sulfide disposal as hazardous waste |

^a Performance data based on data for Boliden's Rönnskärsverken Copper-Lead-Zinc Smelter, as reported in (UNECE 2013)

5.1.1 Some other considerations in the choice of mercury control in smelting and roasting in the non-ferrous metals sector

General principles for the choice of BAT for the point source categories listed in Annex D are described in the introductory chapter to this guidance. Here we discuss some additional aspects of mercury chemistry which might have an influence on the choice of mercury controls in the non-ferrous sector. These are not meant to be prescriptive and may have less applicability for some of the metals listed in Annex D, particularly gold.

Mercury may be present in the process gases from smelting and roasting operations as elemental (Hg^0) or oxidized (Hg^{2+}) mercury, and in the gas or particulate phase. In many cases oxidized mercury is efficiently removed in the normal gas cleaning systems employed in these processes to control acid gases (SO_2 , NO_x) and fine particles. It is therefore essential that these perform well, to reach a low total residual content of mercury in the cleaned gas. This is especially important for the wet ESPs in wet gas cleaning systems. Efficient gas cleaning is also important as impurities in the gas could result in unwanted side reactions in the mercury removal stage. For example, the selenium filter, which is of the fixed bed type, is sensitive to dust deposits on the active porous particles.

Removal of elemental mercury is considerably more difficult than oxidized mercury and most of the commercial technologies are designed to remove vaporous elemental mercury and depend on upstream conventional gas cleaning to achieve high mercury removal. The mercury removal stage is normally installed when mercury content of feedstock or characteristics of the ore make conventional gas cleaning insufficient to remove sufficient amounts of mercury.

Table 5 summarizes some of the factors influencing mercury distribution in a gas cleaning system in the smelting environment.

Table 5: Some factors influencing the mercury distribution in a gas cleaning system (after (Holmström *et al.* 2012))

| Gas characteristic | Consequence for mercury distribution |
|---|--|
| Presence of Se or S^0 or alternatively $\text{H}_2\text{S}_{(\text{g})}$ | Formation of HgSe or HgS (particles) → recovered by bag filter and Wet ESP |
| Very high load of elemental Hg into gas cooling system | Formation and condensation of liquid elemental Hg throughout the system |
| High gas temperature after gas cooling at a B/N tower | Results in relatively high content Hg^0 after B/N tower |
| Function of Wet ESP | A high efficiency is necessary; otherwise, Hg-rich particles will be transferred to acid |
| Presence of oxidized Hg in process gas at a bag filter | Will result in more Hg to bag filter dust |

The gas purity requirements for the mercury removal processes are about the same as for the sulfuric acid plants. In the specific case of the Boliden-Norzinc (BN) process the mercury vapor pressures of

the circulating liquids are sensitive to the temperature. Therefore, the entering gas temperature should be as low as possible. Normal requirements for the inlet gas to the mercury removal stage of the BN, thiosulfate and selenium filter processes are given in Table 6.

Table 6: Gas quality and properties required for the inlet gas to the mercury removal stage of BN, thiosulfate and selenium filter processes (industry data provided by Outotec)

| Parameter | BN process | Thiosulfate process | Selenium filter |
|--------------------|----------------------------|--|----------------------------|
| Dust | max. 1 mg/Nm ³ | max. 1 mg/Nm ³ (after wet ESP stage) | max. 10 mg/Nm ³ |
| Sulfuric acid mist | max. 20 mg/Nm ³ | max. 20 mg/Nm ³ (after wet ESP stage) | max. 20 mg/Nm ³ |
| Gas temperature | max. 40 °C | not critical | max. 90 °C |

Outotec, the major distributor of mercury control technology for smelting has described an approach to the choice of technology (Holmström *et al.* 2012) in cases where more extensive removal of mercury from the gas is required. The three technologies they describe are the Boliden/Norzink process; the Se-filter for use in a static bed with relatively small gas flows; and an activated carbon filter for use in a static bed or injection of activated carbon up-stream of a bag filter. According to Outotec, the choice (Holmström *et al.* 2012) is determined by the process conditions, and may be simply illustrated by the diagram presented in Figure 9. This figure is meant as a guide to possible technology choice and may not be appropriate in many cases, for example where selenium is present in the concentrate. Such technology may not be necessary where a combination of gas cleaning equipment with sulfuric acid plants is operated and sufficiently controls mercury as well as sulfur emissions.

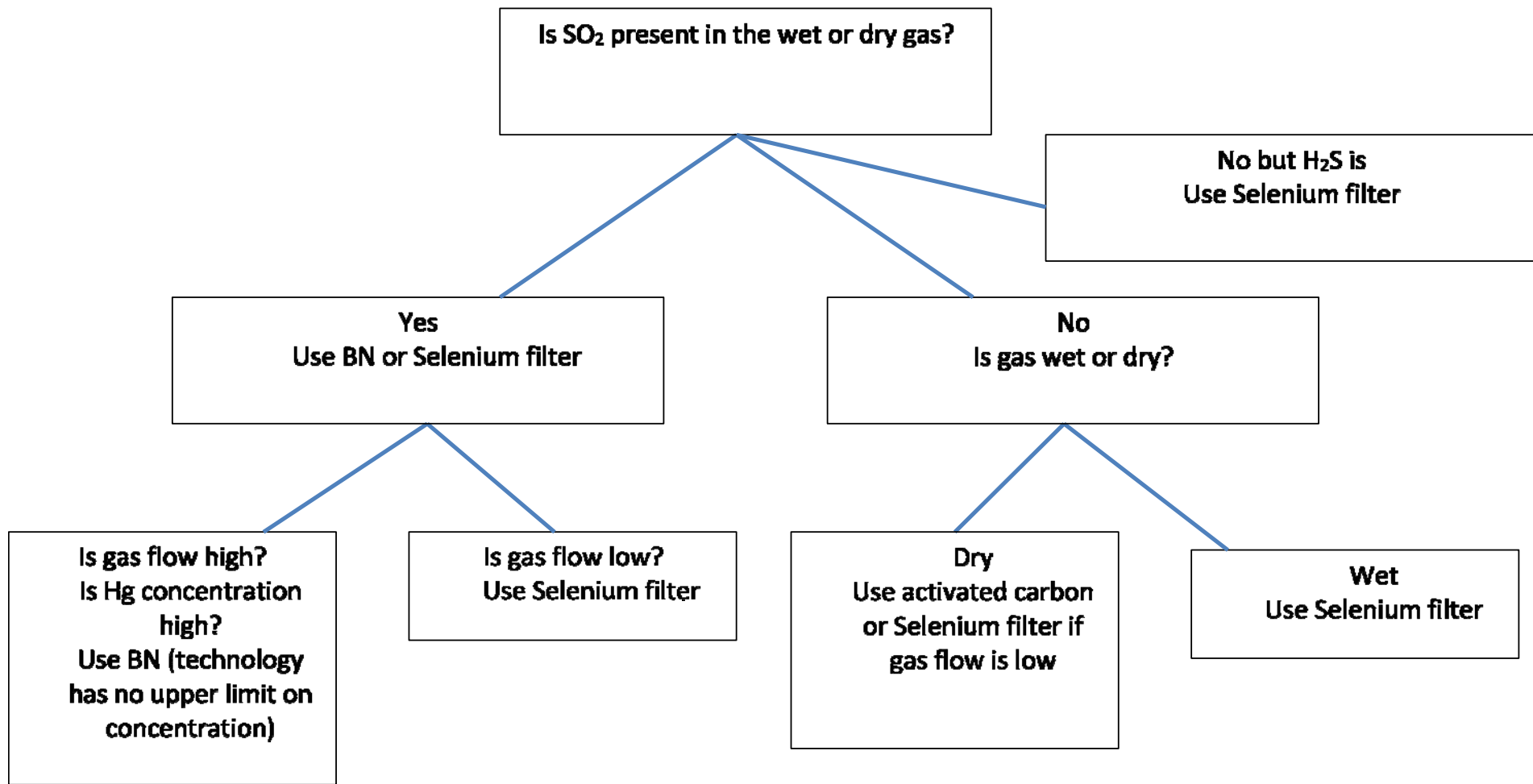

Figure 9: Mercury control considerations where high mercury removal is required and the choice includes the BN, selenium filter and activated carbon processes

5.2 Best Environmental Practices (BEP)

This section describes general Best Environmental Practices (BEP) to control, and where feasible, reduce, atmospheric mercury emissions from smelting and roasting processes used in the production of non-ferrous metals.

To develop and implement specific BEP, careful planning and commitment from all levels within a company are required. The development of BEP may be facilitated by considering applicable regulations, administrative controls and plant management practices.

5.2.1 Environmental management systems

An Environmental Management System (EMS) is a structured approach to managing the environmental aspects of an operation that typically includes: reviewing the company's environmental goals; analyzing its environmental risks, impacts and legal requirements; setting environmental objectives and targets to reduce environmental impacts and comply with legal requirements; establishing programs to meet these objectives and targets; monitoring and measuring progress in achieving the objectives; ensuring employees' environmental awareness and competence; and reviewing progress of the EMS and continuously improving. Recommendations for implementation may include:

- Developing and implementing preventative, predictive and corrective maintenance programs to operate pollution abatement systems effectively.
- Maintaining production equipment to facilitate their normal operation and to minimize process upsets
- Improving operational management, developing contingency plans, conducting regular training of the operators,
- Executing a spill prevention programs and implementing good housekeeping throughout the facility.
- Establishing a monitoring plan for mercury measurement in the relevant stages of the process.
- Developing and maintaining an overall record of mercury emissions at the relevant process and facility level.

5.2.2 Blending feedstocks to control mercury emissions

Blending is an operational process performed to produce a stable and homogeneous feed by mixing ores or concentrates of varying quality, combining the ores or concentrates with fluxes, or mixing in different secondary raw materials. Blending may be used to control mercury emissions when smelter feed materials have extremely variable or higher than desirable mercury concentrations. The treatment of a stable, homogenous feed facilitates steady-state operating conditions in which pollution controls can function more efficiently. In addition, lower overall mercury content in smelter feed would generate reduced mercury concentrations in the off-gas and decrease the mercury emissions to the final stack. In some specific cases the ore may also have very low mercury content, and no additional control measures may be required to achieve low emissions.

For sources that practice blending, the following considerations should be taken into account:

- Blending can be a very dusty operation and high levels of containment, particulate matter extraction and de-dusting should be used. Collected dusts should be returned to the process.

- Wet mixing may also be used to avoid the production of dusts. In some cases, a slurry is produced that is then dewatered and used in a pelletizing process.
- To achieve accurate blends, samples of each feed material should be taken beforehand to analyze the relevant metal contents, including impurities such as mercury. Blends should be planned by combining appropriate ratios of feed materials based on these results. Blending plants, loss-in-weight dosing systems, belt scales, and tracking of loaded volumes can all be used to achieve accurate blends.

5.2.3 Atmospheric mercury emissions

Control measures and strategies should be implemented to reduce the generation of mercury emissions. Care must be taken in designing gas cleaning units, including stacks, to suit local meteorological, topographic and site environmental conditions. Fugitive emissions from point sources which reasonably can be captured by hooding systems and appropriate enclosure of units should be so captured. Recommendations for implementation include:

- Optimizing process design to reduce off-gas emissions and pollutant content; design for continuous operation where technically and economically viable.
- Operating furnaces and reactors under negative pressure and applying appropriate gas cleaning techniques on the extracted gases.
- Sealing of furnaces and reactors, and retrofitting existing furnaces with maximum sealing.
- Conducting parametric monitoring to prevent flue gas condensation and pipeline corrosion due to excess humidity.
- Implementing a leak-detection program and repairing leaks as necessary.
- Applying corrective action to any equipment which generates significant fugitive emissions.

5.2.4 Particulate matter control

Particulate matter (PM) controls are important because PM carries particulate-bound mercury. PM control methods must be considered during the planning stage and emissions tracked. Plants should implement continuous improvement in PM controls during operation including:

- Identifying and regularly inspecting potential PM sources
- Using dust extraction systems with appropriate particulate controls to remove particulates from working areas and buildings.
- Using negative pressure enclosure of on PM-creating units to prevent overflow of particulate-bearing gases.
- Installing bag house filters with more than one chamber to enable inspection and maintenance during operation
- Maintaining the performance of the bag house with regular inspection and bag replacement.

5.2.5 Environmentally sound management and disposal of air pollution control wastes

In order to prevent unnecessary emissions, plants should use the following approaches to achieve appropriate management and disposal of residues generated from air pollution control devices:

containing co-products and

- Safe storage and transport of mercury wastes resulting from air pollution controls (e.g., liquid elemental mercury recovered from the retorts or mercury(I) chloride produced from the Boliden-Norzink process)
- Trade in mercury only in line with Article 3 of the Convention.
- Environmentally sound disposal of mercury wastes.

treatment and recycling or

6 Monitoring of mercury in smelting and refining processes used in the production of non-ferrous metals

General and cross cutting aspects of testing, monitoring and reporting are discussed in the introductory chapter of this document. Specific aspects of mercury emission monitoring inherent to non-ferrous metals processes will be discussed in this section.

In the non-ferrous smelting and refining sector, input materials that may contain mercury include concentrates, fluxes and fuel. In addition to finished metals, the product streams may include metal powders, metal compounds, sulfuric acid and fertilizer. By-product streams could include slags, calomel (mercury(I) chloride, Hg_2Cl_2), while waste streams may include slags, calomel, sludges and precipitates from pollution control equipment.

Mercury emissions can vary significantly within a single facility over time or among facilities conducting similar processes, due to variable mercury content in the materials entering the process. Mercury concentrations can change rapidly in the concentrates, fuel or other inputs such as scrap metal. When conducting sampling, care must be taken, as far as possible, to ensure that the process is operating at steady state representative of normal operating conditions, mercury concentrations in the input streams are representative of normal feeds, and that fugitive emissions are minimized. If the operating conditions are not typical, extrapolation of the sampling data may provide results with a large margin of error.

Given the diversity of processes used within the non-ferrous metals smelting and refining sector, significant process variations can exist, even between facilities producing the same type of metal product. Site-specific characteristics should be taken into account when selecting the most appropriate monitoring method and planning for the sampling campaign. In addition to gathering data on mercury emissions, documentation of the metal production rate is also recommended to allow for the calculation of mercury emissions per tonne of metal.

6.1 Direct Measurement Methods

Impinger sampling

Impinger sampling with wet chemicals has been the traditional sampling method used to measure mercury concentrations in gas within the non-ferrous metals smelting and refining sector. Due to the complexity and cost of this method, impinger sampling is done less frequently, such as quarterly or annually only. While this method typically provides reliable data for the sampling duration, the results may not be representative if mercury concentrations are variable over short time periods.

Sorbent traps and sorbent trap monitoring systems

In the non-ferrous metals smelting and refining sector, sorbent trap monitoring can be used effectively to provide data on mercury concentrations in exhaust gases over periods of time. While this method would not provide real-time results, the data obtained would indicate the operating performance over the previous set time period. With this feedback loop approach, adjustments to the process can then be made as needed.

Sorbent trap monitoring is effective in gas streams with low particulate matter concentrations. In a non-ferrous facility, the final stack is usually the appropriate location for installation of a sorbent trap monitoring system. At this stage, the cleaned stack gas should contain low levels of mercury, particulate matter and other pollutants.

Continuous emissions monitoring systems (CEMS)

CEMS for mercury have not yet been widely used in the non-ferrous metals smelting and refining sector. CEMS have been commonly used for measuring low levels of mercury concentration in high exhaust flowrates, such as in the coal-fired power industry. In comparison, many non-ferrous smelting facilities emit more chemically complex exhaust gases with lower flowrates and higher levels of mercury concentration in more complex gas streams.

potentially

In facilities operating multiple stacks, it may be more appropriate to install the CEMS on the final stack to monitor releases to the environment. At that final stage in the process, the stack gas should have undergone cleaning processes where the majority of the air pollutants in the stack gas would have already been removed, such as through particulate matter controls, mercury removal, and acid production. The data collected would provide indicative, real-time trends on operating performance. If the quantity of mercury in the feed streams is known, mercury removal efficiency can be calculated using the CEM data.

6.2 Indirect measurement Methods

Mass balance

While a mass balance would provide data for a specified time period, not on a real-time basis, it may be useful as an indicative tool to track operating performance and mercury removal efficiency provided content of mercury in the feedstocks, products and other key streams, is sufficient to allow a reliable calculation.

Normal operating practice at a non-ferrous metals smelting and refining facility should already include regular sampling and assaying (chemical analysis) of the metals content in the feedstocks, products and other key streams to ensure efficient process control. Inclusion of mercury as an analyte in these streams yields essential data to be used in the mass balance. Information on the chemical content of purchased fuel can be provided by the fuel supplier. Given that a smelter or refinery usually conducts in-house assay analysis of metals content in its main inputs/outputs on a daily basis, the facility should consider conducting its own mercury analyses at an incremental cost.

To calculate a facility's annual mercury emissions using a mass balance, the mercury concentrations and mass flowrates of all streams should be tracked and recorded over the yearly period, which requires a high degree of effort. In addition, all streams that can accumulate mercury should be tracked. Mercury mass data would be calculated by multiplying the mercury concentration by the stream mass flowrate and the time period (e.g. one year).

Due to the inherent variability of mercury mass flow rate measurements and mercury accumulation measurements, and multiple input and output flows, it may be challenging to reach closure on a mass balance. For well-controlled processes where the mercury emission rate is only a fraction of the mercury feed rate, direct measurements of exhaust streams through sampling would be more appropriate than completing a mass balance.

Predictive emissions monitoring systems (PEMS)

PEMS may not be a reliable method of mercury emissions monitoring within the non-ferrous metals smelting and refining sector. In this sector, mercury content in furnace feedstocks can change significantly over short periods, depending on the concentrates processed. Even in a facility processing concentrates from a dedicated mine, the mercury content can fluctuate substantially depending on the location of mining within the ore body. As a result, the establishment of correlations between surrogate parameters and mercury emissions may not produce representative results. If PEMS are considered, thorough analysis should first be done to determine the uncertainty of the method on a case-by-case basis.

Emission factors

For the non-ferrous smelting and refining sector, mercury emissions can vary significantly within a single facility over time or among facilities conducting similar processes due to changing mercury contents in the input streams. Therefore, when using emission factors, the estimated emissions may contain a high margin of error. In particular, estimates using general published emission factors should be considered as a rough indication of emission levels. An alternative approach would be to develop site-specific emission factors based on actual sampling data and source activity information.

7 References

- UNEP (2008). Technical Background Report to the Global Atmospheric Mercury Assessment, Arctic Monitoring and Assessment Programme/ UNEP Chemicals Branch, 159 pp.
- UNEP (2013). Technical Background Report for the Global Mercury Assessment 2013, Arctic Monitoring and Assessment Programme/ UNEP Chemicals Branch, vi + 263pp.
- BREF NFM (2014). Best Available Techniques Reference Document for the Non Ferrous Metals Industries (BREF NFM), available at: http://eippcb.jrc.ec.europa.eu/reference/BREF/NFM_Final_Draft_10_2014.pdf, IPTS, Joint Research Centre (JRC), European Commission, Sevilla/Spain, 1242pp.
- Coleman, R. T. J. (1978). Emerging Technology in the Primary Copper Industry. Prepared for the U.S, EPA; data2.collectionscanada.ca/pdf/pdf001/p000001003.pdf accessed on 07th April 2014, pp.
- Habashi, F., 1978. Metallurgical plants: how mercury pollution is abated. *Environmental Science & Technology* 12, 1372-1376.
- Holmström, Å., Hedström, L., Målsnes, A. 2012. Gas Cleaning Technologies in Metal Smelters with Focus on Mercury. Sino-Swedish Cooperation on Capacity Building for Mercury Control and Management in China (2012-2013). Outotec.
- Hultbom, K. B. 2003. Industrially proven methods for mercury removal from gases. EPD congress, The Minerals, Metals & Materials Society (TMS).
- Morgan, S., 1968. The Place of the Imperial Smelting Process in Non-ferrous Metallurgy.
- Reimers, J. H., et al. 1976. A review of Process Technology in Gases in the Nonferrous Metallurgical Industry for the Air Pollution Control Directorate, nepis.epa.gov/Exe/ZyPURL.cgi?Dockey=91018I2W.txt accessed on 07th April 2014, Jan H. Reimers and Associates Limited, Metallurgical Consulting Engineers, Oakville, Ontario, Canada,.
- Schulze, A., 2009. Hugo Petersen - Competence in gas cleaning systems downstream nonferrous metallurgical plants. The Southern African Institute of Mining and Metallurgy - Sulphur and Sulphuric Acid Conference 2009, 59-76.
- Sundström, O. 1975. Mercury in Sulfuric Acid: Bolden Process Can Control Hg Levels during or after manufacture. *Sulfur* No. 116, The British Sulfur Corp., January – February 1975: 37-43.
- Takaoka, M., Hamaguchi, D., Shinmura, R., Sekiguchi, T., Tokuchi, H. 2012. Removal of mercury and sulfuric acid production in ISP zinc smelting. International Conference on Mercury as a Global Pollutant, Abstract 16-PP-107.
- UNECE (2013). Guidance document on best available techniques for controlling emissions of heavy metals and their compounds from the source categories listed in annex II to the Protocol on Heavy Metals, UN Economic Commission for Europe: Executive Body for the Convention on Long-range Transboundary Air Pollution, 33pp.